



Features

- Modular pressure transmitter with internal or flush-mounted diaphragm
- Output signal:
 - 4...20 mA
 - HART® protocol (rev. 6), option
 - PROFIBUS PA, option
- Function modules
 - Multifunctional display with 5-segment digital display and bar graph
 - Switching module with 2 floating channels, maximum 0.5 A switching current, electrically isolated at all sides, without additional auxiliary power
- Function module replacement on site without recalibration "plug and measure"
- Limits of measuring range 0...80 mbar to 0...400 bar
- Accuracy: $\leq 0.15\%$
- Turndown 5:1
- Degree of protection IP 66, piezoresistive measuring cell directly aerated

Options

- Explosion protection for gases and dust
- Classification per SIL 2
- Inspection certificates
 - material certificate as per DIN EN 10204-3.1
 - calibration certificate as per DIN EN 10204-3.1



Application area

- Chemical and petrochemical industry
- Process engineering
- General process technology

Application

The modular pressure transmitter PASCAL CV is suited for measuring the relative and absolute pressures of gases, vapors and liquids.

PASCAL CV - the modular pressure transmitter

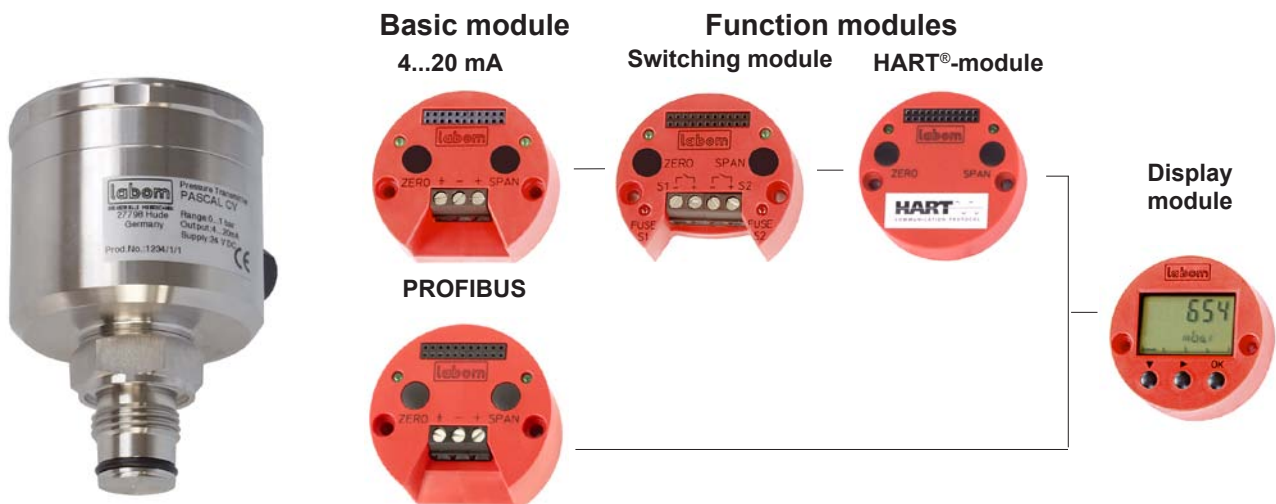

Process connection: all standard thread variants with internal or flush-mounted diaphragm

Technical Data**Instrument ranges**

nominal range	Turndown	measuring ranges	measuring spans ²		overload limits	vacuum tight at < 50 °C ¹
			min. span	max. span		
0.4 bar	5 : 1	-0.4...+0.4 bar	80 mbar	0.8 bar	1 bar	400 mbar abs
1 bar		-1...+1 bar	0.2 bar	2 bar	3 bar	40 mbar abs
4 bar		-1...+4 bar	0.8 bar	5 bar	10 bar	20 mbar abs
16 bar		-1...+16 bar	3.2 bar	17 bar	60 bar	20 mbar abs
40 bar		-1...+40 bar	8 bar	41 bar	100 bar	20 mbar abs
100 bar		-1...+100 bar	20 bar	101 bar	150 bar	20 mbar abs
400 bar		-1...+400 bar	80 bar	401 bar	600 bar	---
4 bar abs		0...4 bar abs	0.8 bar abs	4 bar abs	10 bar abs	20 mbar abs
16 bar abs		0...16 bar abs	3.2 bar abs	16 bar abs	60 bar abs	20 mbar abs

¹ Long-term vacuum measurements at temperatures above +50°C may cause changes in the properties of the measurement device (only for piezoresistive measuring systems). Vacuum-proof designs are available upon request.

² calibrated measuring span for devices with PROFIBUS PA basic module

**Housing design**

Housing	hygienic housing design with screw cap
Material	housing: st. steel mat.no. 1.4301 (304) window: Macrolon gasket: NBR O-ring
Construction	two-chamber system, minimum housing volume, excellent moisture and condensate protection
Pressure compensation	PTFE filter system
Degree of protection	IP 66 per EN 60529
Climatic category	DIN EN 60721 3-4, 4K4H
Electrical connection	· screwed terminals 1 mm ² , cable entry fitting through screwing · circular connector M 12
Weight	standard device with G 1/2 without function modules approx. 0.65 kg

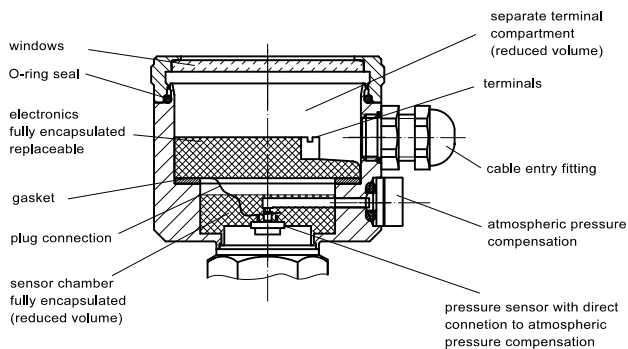
Housing design**Process connection**

Variants / material see order code

Measuring system

Sensor type	piezoresistiv	thin film
Sensor filling	foodstuff oil as per FDA	---

Materials (wetted parts)

Sensor type	piezoresistiv	thin film
Sensor diaphragm	1.4404/1.4435(316L)	1.4542(630)
Socket	1.4404/1.4435(316L)	1.4301/1.4404(304/316L)

Temperature ranges

Ambient temperature	-20 to 85°C
Process temperature	-20 to 90°C
Allowed storage temperature	-40 to 85°C

Note safety values as per examination certificate!

Supply

Basic module	4...20mA	PROFIBUS PA
Standard design	12...40 VDC	9...32 V DC
Ex- proof design	12...30 VDC	

Output

General	
Delay time	approx. 160 ms
Measuring cycle	6 measurements / second
Meas. range setting	Turndown 5:1

Basic module: 4...20 mA

Signal	4...20 mA, 2-wire
Current range	3.8...20.8 mA
Current limitation	approx. 22 mA
Alarm state	< 3,6 mA, optional > 21 mA
Damping	0...120 seconds
Load	$R \leq \frac{U - 12 V}{22.5 \text{ mA}}$ (Ohm)

Basic module: PROFIBUS PA

Output signal	digital output signal IEC 61158-2
Protocol	EN 50170 - PROFIBUS PA, Profile 3.0
Sensor address	0...126 (126 = factory setting)
Power consumption	constantly 11 mA
Fault current I_{FDE}	2 mA
Damping	0...300 seconds
Parameterization	SIMATIC PDM

Accuracy

General	
Limit point setting	per DIN 16086
Reference conditions	per DIN EN 60770-1
Calibration position	vertical mounting position
Linearity errors	≤ 0.15 % of span TD 5:1 no modification
Hysteresis	≤ 0.05 % of nominal range
Repeatability	≤ 0.05 % of nominal range
Influence of mounting position	≤ 3.5 mbar
Long-term drift	≤ 0.1 % year of nominal range
DIN EN 60770-1	
Temperature effect	
Lower range value / upper range value	
range 0...60 °C	± 0.15 %/10 K of nominal range
range <0°C, >60°C	± 0.2 %/10 K of nominal range

Approval/tests

Interference emission	EN 55011
Noise immunity	EN 61326*
Ex-approval	TÜV 04 ATEX 2387 X ⊗ II 1/2G Ex ia IIC T4/T5/T6 Ga/Gb ⊗ II 2G Ex ia IIC T4/T5/T6 Gb ⊗ II 2D Ex ia IIC T xx °C Db

Classification per SIL 2 for basic module 4...20 mA, switching module, display module and HART module, TÜV-Reg.-No. 44 207 09 555548-001.

* Devices with cable gland or switching outputs might suffer from a short-time measuring deviation in case of strong electromagnetic fields (EN 61000-4-3).

Function modules

Display module (multifunctional display) optional

pluggable with automatic module detection - plug and measure -

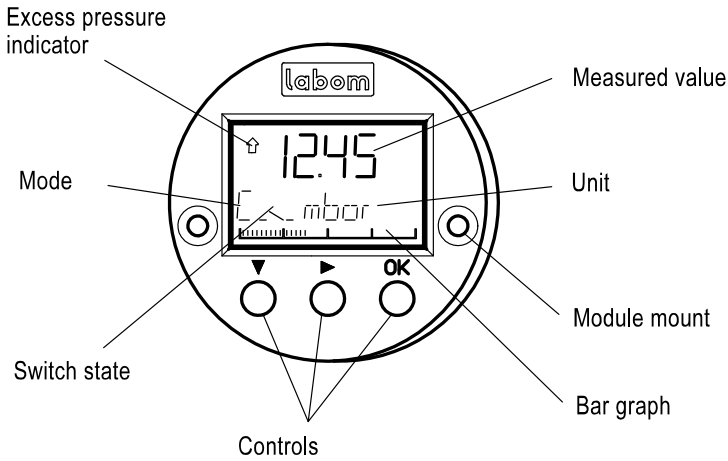

- Module housing made of ABS, encapsulated electronics unit
- Many operating mode menus
- 5-segment pressure read-out with unit
- Read-out display
 - pressure (standard)
 - percent *
 - current *
 - sensor temperature
- Bar graph 36 segments $\hat{=}$ 0...100%
- Measuring circuit test (current sensing function) *
3.55...22.0 mA *
- Alarm indicator on display
- Switching function indicator (with switching module) *

* not with basic module PROFIBUS PA

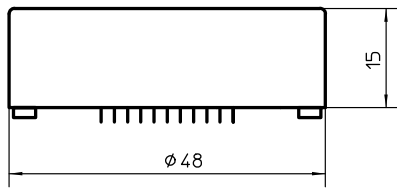

Operator menus	
4...20 mA	PROFIBUS PA
meas. range selection	min-max-value
damping	pressure trimming
min-max-value	system-info
characteristic	factory data reset
pressure units	BUS address
measuring circuit test	
alarm state	
current trimming	
pressure trimming	
table function	
system info	
factory data reset	
switch points	
hysteresis	
switching function	
HART address	
Current mode	

HART module, optional (for basic module 4...20 mA)

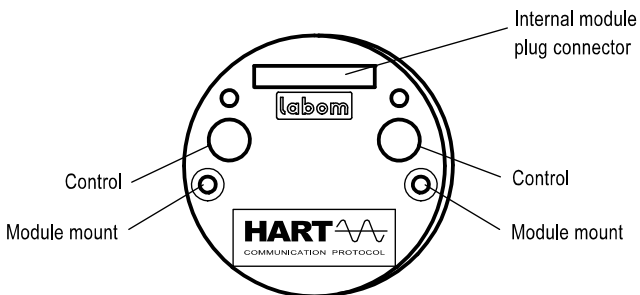

- HART protocol, revision 6.5
- Response characteristic FSK
- Load with HART communication
 - with HART modem 230...500 Ω
 - with HART communicator 230...1100 Ω
- Parameterizing by
 - operating elements
 - HART communication
 - PDM 6.0
 - AMS
 - 375 Field Communicator

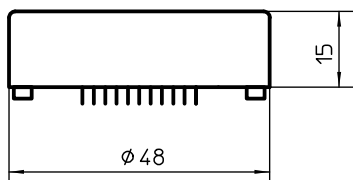

Switching module, optional (not with basic module PROFIBUS PA)

pluggable with automatic module detection - plug and measure -

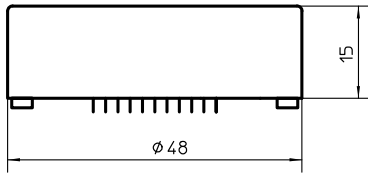
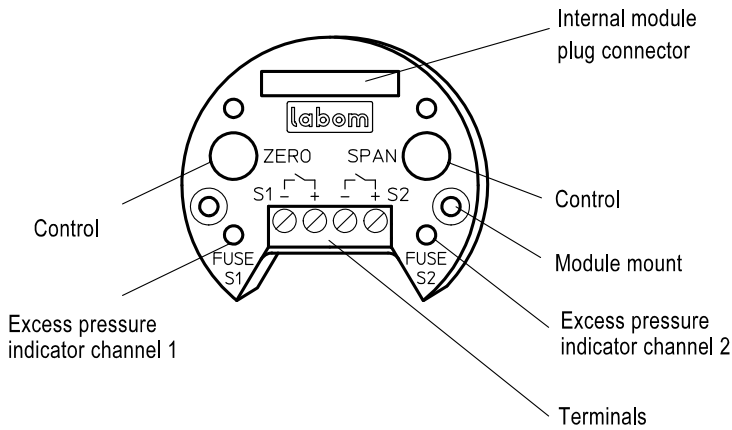

- No additional auxiliary power required
- Module housing made of ABS, encapsulated electronics unit
- Electronic switch for 2 limit values, voltage free, short-circuit-proof
- Switching capacity 30 V DC / 0.5 A ($R_i < 0.3 \Omega$)
- Overload indicator: LED red, overload or short-circuit
- Fusible cut-out at overload /short-circuit with automatic reset
- Switch points: 0.0 - 100.0% adjustable
Standard: 50.0%
- Switching function: maker or breaker, adjustable
Standard: breaker
- Device of circuit: contact open
- Hysteresis: 0.0% to 100.0%, adjustable
standard: 0.1%
falling or rising, adjustable,
standard: falling
- Switching rate: 6 Hz
- Electrically isolated to all sides
Insulation voltage: 500 V, 2.5 kV/2 sec.
- Electrical connection: terminal blocks 1 mm²

Profibus module description and HART® connection upon request

Hysteresis functions

- falling hysteresis -

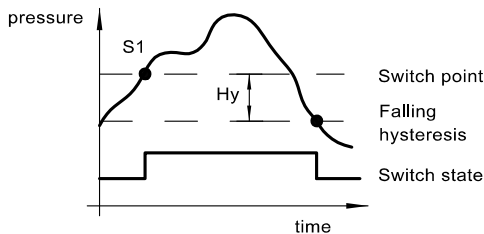

- rising hysteresis -

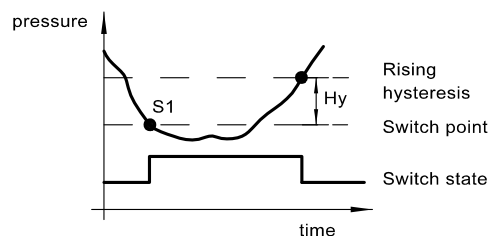

Parameterizing

The module selected determines which parameters can be set.

operating menus	display of display module	parameter		basic module: 4...20 mA				basic module: PROFIBUS PA		
		variability	standard	basic module	switching module	display module	HART®-module	basic module	display module	PDM
zero point *	RANGE / Zero	see instrument ranges	nominal range	x	x	x	x	—	—	x
measuring span *	RANGE / Span	see instrument ranges	nominal range	x	x	x	x	—	—	x
damping	DAMP	4...20 mA: 0...120 sec. Profibus: 0...300 sec.	0.0 sec.	w	—	x	x	—	—	x
min-max-value	HI / LO	pressure and temperature resettable	—	—	—	x	x	—	x	x
characteristic	FUNC	linear, table	linear	w	—	x	x	—	—	x
pressure unit	UNIT	bar, mbar, kPa, MPa, mmH2O, mH2O, kg/cm ² , PSI	bar	w	—	x	x	—	w	x
measuring circuit test	LOOP	3.55...22 mA	—	—	—	x	x	—	—	—
alarm state	ALARM	<3.6 mA, >21.0 mA	<3.6 mA	w	—	x	x	—	—	—
current trimming	I-CAL	-2 %...+5 %	—	—	—	x	x	—	—	—
pressure trimming	P-CAL	zero point -50...+50 % of n.r. span -10...+10 % of n. range	—	—	—	x	x	x	x	x
table function	TABLE	2...31 points in table	0 % = 4 mA 100 % = 20 mA	—	—	x	x	—	—	—
system info	INFO	software, serial number, revision level	—	—	—	x	x	—	x	x
factory data reset	RESET	—	—	—	—	x	x	—	x	x
BUS address	BUS	0...126	126	—	—	—	—	w	x	x
switch points	SWCH1(2)	0.0...100.0 % of nominal range	50 %	—	x	x	x	—	—	—
hysteresis	SWCH1(2)/Hyst.	0.0...100.0 % of nominal range	0.1 % hyster.falling	—	w	x	x	—	—	—
switch function	SWCH1(2)/SwTyp	breaker, maker	breaker	—	w	x	x	—	—	—
HART address	HART/Adres	0...63	0	—	—	x	x	—	—	—
HART current	HART/CUrr	fixed/float	FLOAT	—	—	x	x	—	—	—
write protection	—	ON, OFF	OFF	x	x	x	x	x	x	x

x = configurable

w = factory setting

* = calibrated measuring span for devices with PROFIBUS PA basic module

Connection diagram

Basic module: 4...20 mA / PROFIBUS PA

Internal terminals with cable gland design

Circular connector ¹

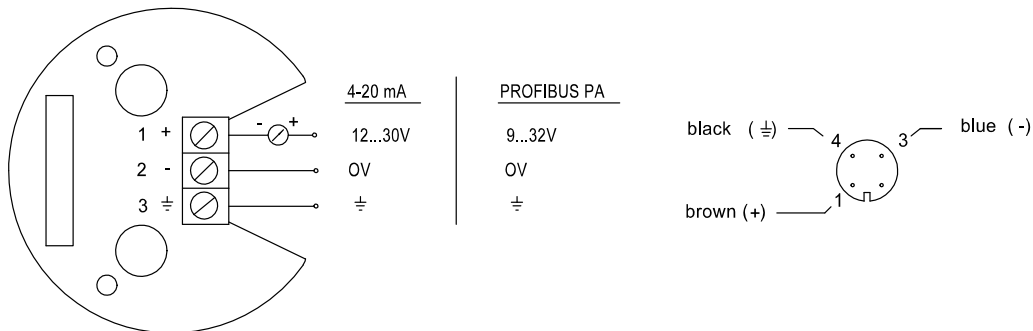

Switching module (only with basic module: 4...20 mA)

Internal terminals with cable gland design

Circular connector ¹

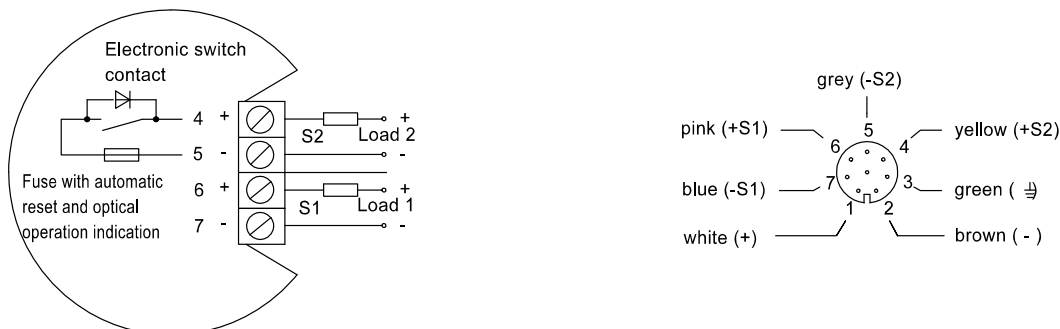

¹ color code as Binder series 763

Dimensions/Designs

Housing

housing design type 17

- basic module: 4...20 mA
- with one function module (optional)
- basic module: PROFIBUS PA

housing design type 25

- basic module: PROFIBUS PA
- with display module (optional)

housing design type 32

- basic module: 4...20 mA
- with two function modules (optional)

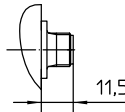
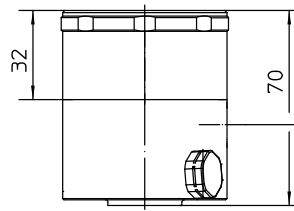
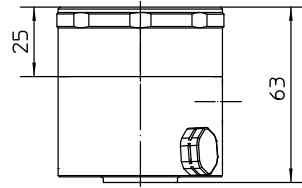
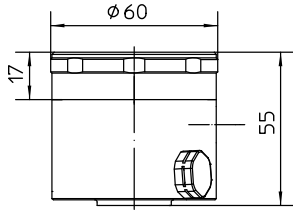

for circular connector
M12x1; 4 pole/8 pole
for 4...20 mA/PROFIBUS PA

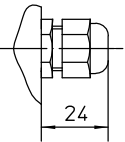

cable gland
M16x1,5 f. cable ø4,5-10

Instruments without LCD module come with closed cover (with no glass face cover).

Process connections piezoresistiv

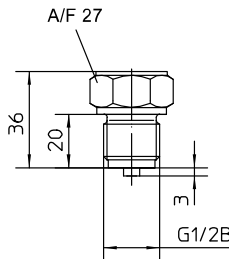

Standard internal diaphragm G1/2B

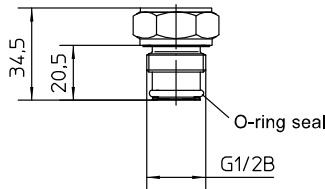

Flush mounted diaphragm with O-ring seal G1/2B

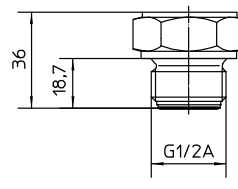

flush mounted diaphragm G1/2A

Process connections thin film

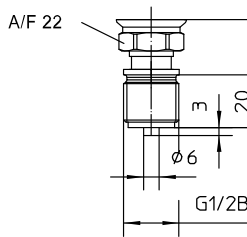

G1/2B DIN EN 837-1

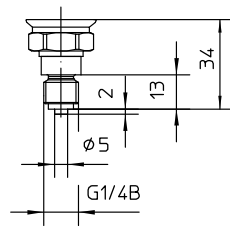

G1/4B DIN EN 837-1

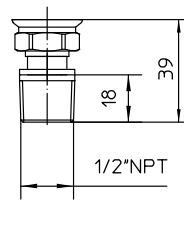

1/2\"NPT

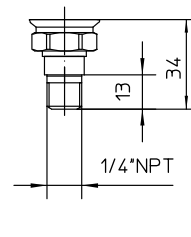

1/4\"NPT

Screw-in hole/welded socket for flush mounted diaphragm with O-ring

Screw-in hole (process)

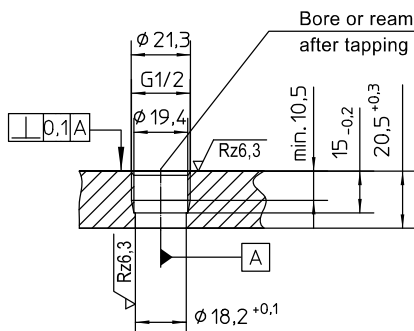

Welded socket Stainless steel

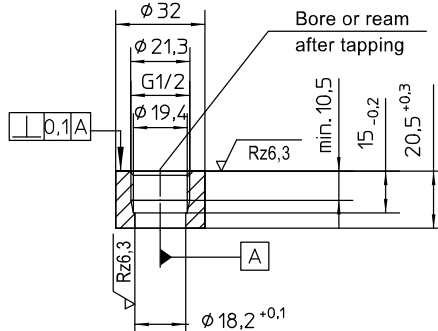

order code: MC 1000-A1

Order Details - please give additional specifications for models not listed -

PASCAL CV pressure transmitter for general application										CV310 .	
explosion protection	· without									0	
	· Ex-protection, types of ex-protection as follows									1	
nominal range	nominal range (Turndown 5:1)	overload limit (bar)	connection DIN EN 837-1		connection		connection with O-ring G 1/2 B	connection DIN 3852 G 1/2 A	sensor type		
			G 1/2 B	G 1/4 B	1/2 NPT	1/4 NPT					
	0,4 bar	1	x	-	-	-	x	x	piezo-resistiv	A1051	
	1 bar	3	x	-	-	-	x	x		A1053	
	4 bar	10	x	-	-	-	x	x		A1056	
	16 bar	60	x	-	-	-	x	x		A1059	
	40 bar	100	x	-	-	-	x	x		A1061	
	100 bar	200	x	-	-	-	-	x		A1063	
	400 bar	600	x	x	x	x	-	-	thin film	A3066	
4 bar abs	10	x	-	-	-	x	x	piezo-resistiv	B1056		
16 bar abs	60	x	-	-	-	x	x		B1059		
measuring range	0 to nominal range, unit: bar (standard)										F10
	0 to nominal range, unit: mbar										F11
	0 to nominal range, unit: kPa										F22
	0 to nominal range, unit: MPa										F23
	0 to nominal range, unit: mmH2O										F30
	0 to nominal range, unit: mH2O										F32
	0 to nominal range, unit: kg/cm ²										F41
	0 to nominal range, unit: psi										F50
	set from... to... unit (please fill in details) not with PROFIBUS PA										F80
adjusted and calibrated from to, unit (pls.fill in details), see below for calibration report										F81	
output signal	4...20 mA, rising characteristic (standard)										H11 ..
	20...4 mA, falling characteristic										H15 ..
	4...20 mA with HART function module, HART protocol rev. 6										H21 ..
	setting 1	damping	0.0 sec. (standard)								0
			0.0...120.0 sec., set to (please fill in)								1
	alarm state	< 3.6 mA (standard)								0	
> 21.0 mA								1			
PROFIBUS PA, IEC 61158-1, Profile 3.0										H41	
display module	without										M1
	multifunctional display with 5-position digital display and bar graph, pluggable										M2
switching module (not with PROFIBUS PA)	without switching module										N10
	switching module with 2 contacts, pluggable, switching capacity 30 V DC / 0.5 A										N5 .
	setting 1)	standard, s."Techn. description of switching module" at the factory, specify as required								0	
electrical connection	circular connector	M 12x1 (4 pin)								T30	
		M 12x1 (8 pin - required for switching module)								T31	
	cable gland	M16x1.5								T20	
		· polyamide black								T21	
		· brass nickel-plated								T22	
process connection	sensor type piezoresistiv	· diaphragm female				· G 1/2 B per DIN EN 837-1				K1010	
		· diaphragm flush-mounted				· G 1/2 B with O-Ring from EPDM				K1110	
	sensor type thin film	· diaphragm female				· G 1/2 A per DIN 3852				K1150	
						· G 1/4 B per DIN EN 837-1				K1002	
						· G 1/2 B per DIN EN 837-1				K1010	
						· 1/2" NPT				K1070	
				· 1/4" NPT				K1072			
order code (example):										CV3100 A1051 F10 H1100 M2 N10 T20 K1010	
additional features (to be indicated in case of need, only)											
explosion protection ²	· Ex II 2G Ex ia IIC T4/T5/T6 Gb, Ex II 2 D Ex ia IIC T xx °C Db									S68	
	· Ex II 1/2G Ex ia IIC T4/T5/T6 Ga/Gb									S66	
PROFIBUS PA	· BUS address, factory setting 0...126, standard, pls specify									Z61	
	· measuring-point number/identification max. 32 characters, pls. specify									Z62	
	· measuring-point text max. 32 characters, pls. specify									Z63	
certificates											
material certificate as per DIN EN 10204-3.1, wetted parts ⁴										W1020	
inspection certificate as per DIN EN 10204- 3.1, calibration certificate with 5 measuring points										W1201	
functional safety as per EN 61508, classification per SIL 2 ³										W2602	
accessories											
HART Modem	· RS 232-Interface									MC1020	
	· USB-Interface									MC1040	
	· USB-Interface, Ex									MC1041	
stainless steel welded socket G 1/2"										MC1000-A1	

¹ parameterization see page 5, ² Ex-design not possible with switching module, ³ not with PROFIBUS PA, ⁴ only for piezoresistive measuring systems